



## Best™ Iodine-125 & Palladium-103 Seeds

- We manufacture both I-125 & Pd-103 seeds in Springfield, Virginia USA
- Best Medical makes custom seeds and strands to your exact specifications — any source, any configuration, any time!
- Best visualization in ultrasound, fluoro, X-ray, CT and MRI, facilitating real-time dosimetry
- Assistance setting up new programs (licensing, procurement of equipment, proctoring, reimbursement consulting, patient education and marketing)



Best™ Iodine-125 Seed

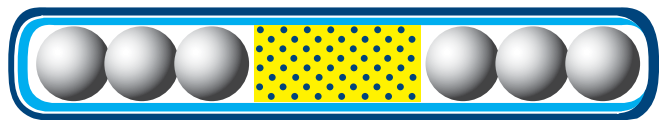

Best™ Palladium-103 Seed

We ship your order within  
**24 hours**  
Sterile and Non-Sterile

“A unique aspect of the Best™ seed is its 5 mm length. Best also provides 5 mm laser-cut spacers, which do not have flared edges. With the Best™ seed/spacer combination, we can be more confident of accurate seed placement.” †

“Best™ Model 2301 seeds are of superior design as they show up more distinctly in transverse ultrasound and fluoroscopic images.” †

“Best™ Model 2301 is the most isotropic of all the I-125 sources currently available. The source is a double encapsulated source.” ††

“Best™ Model 2301 characteristic x-rays have no significant effect on the photon spectrum and the source emits an essentially pure I-125 decay scheme spectrum.” ††

† Communication from J. Limmer, UW Cancer Center Wausau Hospital, Wausau, Wisconsin - Dated December 14, 2000  
†† B.H. Heintz, R.E. Wallace & J.M. Hevezi, Med. Phys. 28(4) 671-682 (2001)

# Best™ Iodine-125 and Palladium-103 Seeds One World — One Source — The Best!

**Think<sup>5</sup>**  
For accuracy!

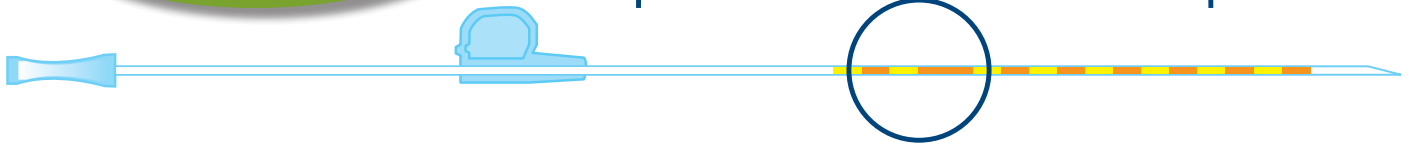
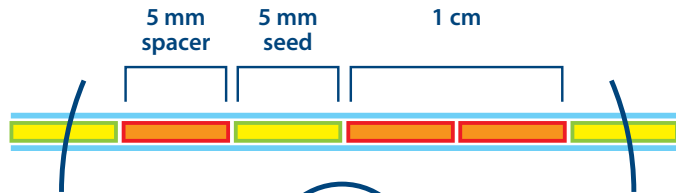

**Best™ Iodine-125 Seed**

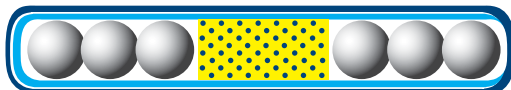

**Best™ Palladium-103 Seed**

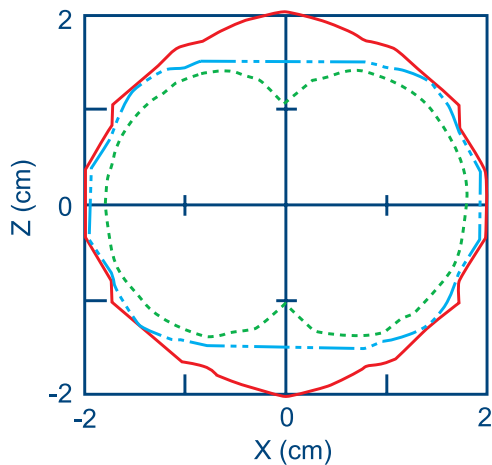

**Experimentally Measured Isodose Curves of 20 cGy/h from I-125 Seeds, Best™ Model 2300 Series (solid red line), Model 6702 (broken blue line) and Model 6711 (dotted green line)**

*Ravinder Nath and Anthony Melillo  
Medical Physics, 20(5), 1480 (1993)*

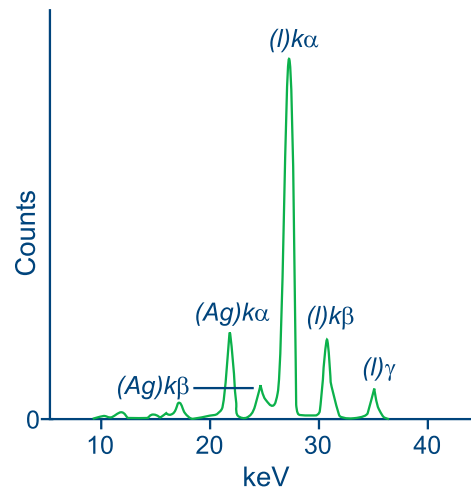
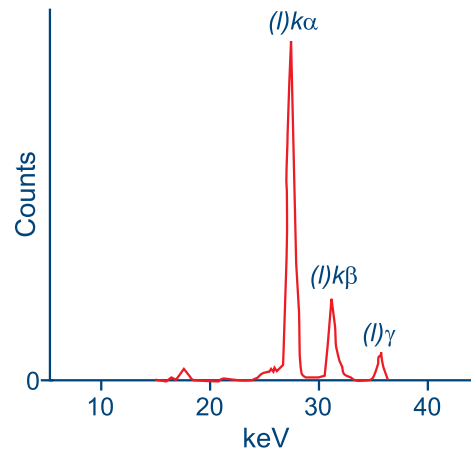

**Comparison of Best™ 125 Iodine Seed Photon Energy (top) versus Model 6711 (bottom)**

*Presented by Surendra N. Rustgi, Ph.D.  
1991 AAPM Annual Meeting*

**BEST MEDICAL**

versus

**OTHERS**

We manufacture both I-125 and Pd-103 seeds in the U.S. and supply directly to hospitals.	Not all of them manufacture both seeds.
Our seeds are made with two titanium capsules. Because of this double-wall encapsulation, our seeds are mechanically strong and can be handled easily with regular forceps.	Use single-wall encapsulation or titanium tube. The seeds sometimes bend or crumble in handling, causing a problem in implantation.
Best I-125 seeds emit pure I-125 spectrum.	Not all of them emit pure I-125 decay scheme spectrum. Some of them emit silver x-rays, thereby lowering the average energy to close to that of Pd-103.
Best's seeds are rated the most isotropic for dosimetry and comply with AAPM and RTOG's dosimetry prerequisites for treatment and clinical trials.	Not all comply with these requirements, and not all seeds are isotropic.
Our seeds are very precise in physical dimensions. They are 5 mm long and 0.8 mm in diameter. Best's seeds fit Mick cartridges snugly and do not jam during implantation.	Seeds vary in length from 4.3 mm to 5 mm. Because of this, Mick cartridges were designed to accommodate up to 5.1 mm seeds, but seed length variation sometimes results in seeds jamming, causing them to rupture.
Spacers are precision made and are 5 mm in length and 0.8 mm in diameter.	Dimensions of spacers from other companies vary.
Our spacers are provided free of charge.	Others may charge for spacers.
Best provides sterile, pre-loaded Mick-style cartridges, needles and strands on short notice.	Not all of them provide on short notice.
Our seeds have the best visualization in ultrasound, fluoro, X-ray, CT, and MRI, facilitating real-time dosimetry.	Seeds do not always have excellent visualization in all media, and real-time dosimetry may not be easily accomplished.
We custom manufacture each order, thereby providing the exact seed activity the customer needs.	Not all of them provide exact activity needed. Customer is limited to a range of seeds available in inventory.
Our packaging is far superior and uses stainless steel containers and sturdy color-coded boxes – Green for Pd-103 and Blue for I-125 seeds.	Use lead containers and do not color-code packaging.
Best has been in Brachytherapy longer than any of its competitors – since 1977. Because of this, we understand patient concerns, the demand for perfection, and the needs of hospital personnel.	Many of them have been in brachytherapy for only a few years.
Best is open 8 am – 7 pm (Eastern Time), M–F. We can send shipments 7 days a week and as late as midnight M–F. We provide an emergency contact number and someone is available 24 hours a day to respond.	Not available.
We help set up new programs with licensing, procurement of necessary equipment, proctoring, reimbursement consulting, patient education, and marketing.	Not all of them provide this support.
Best is considered the “Gold Standard” for customer service and has consistently maintained its excellent reputation throughout its history of serving the Brachytherapy community.	Others are not as good as Best.
Best has a Total Solutions™ program for Prostate Cancer Treatment. We also manufacture Sonalis and TargetScan Ultrasound Systems, Stepper/Stabilizer, Treatment Planning Systems, Brachytherapy Chair/Table, etc.	Others do not.



*Specifications within are subject to change.*



# Best™ medical international

**Localization Needles, Fiducial Markers...and more!**

## Best™ Breast Localization Needles



Best provides localization needles with Iodine-125 seeds and markers which are visible in Ultrasound/ X-ray/Fluoro/CT/MRI

- Best localization needles are available in 5, 7, 10 and 15 cm lengths
- Available in various ranges of seed activities with a shelf life of 90 days
- Needles are supplied sterile and are individually packaged and shielded



**Loose Seed Loaded into Localization Needle**



**Seed in Tissue-Absorbable Strand Material**

## Did you know?

**Best Medical has been serving the radiation therapy community since 1977!**

## Best™ Gold Fiducial Markers



**Stranded**

**Loose**

**Best Medical can provide any standard or customized gold marker configuration made to your exact specifications, sterile or non-sterile!**



Best Medical International, Inc. 7643 Fullerton Road, Springfield, VA 22153 USA  
 tel: 703 451 2378 800 336 4970 [www.besttotalsolutions.com](http://www.besttotalsolutions.com) [www.teambest.com](http://www.teambest.com)

AFRICA | ASIA | EUROPE | LATIN AMERICA | MIDDLE EAST | NORTH AMERICA